

**RADIATION HARDENED
POWER MOSFET
THRU-HOLE (TO-257AA)**

**IRHY57034CM
JANSR2N7483T3
60V, N-CHANNEL
REF: MIL-PRF-19500/702**



Product Summary

Part Number	Radiation Level	RDS(on)	Id	QPL Part Number
IRHY57034CM	100K Rads (Si)	0.04Ω	18A*	JANSR2N7483T3
IRHY53034CM	300K Rads (Si)	0.04Ω	18A*	JANSF2N7483T3
IRHY54034CM	500K Rads (Si)	0.04Ω	18A*	JANSG2N7483T3
IRHY58034CM	1000K Rads (Si)	0.048Ω	18A*	JANSH2N7483T3

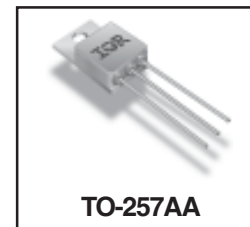

International Rectifier's R5™ technology provides high performance power MOSFETs for space applications. These devices have been characterized for Single Event Effects (SEE) with useful performance up to an LET of 80 (MeV/(mg/cm²)). The combination of low RDS(on) and low gate charge reduces the power losses in switching applications such as DC to DC converters and motor control. These devices retain all of the well established advantages of MOSFETs such as voltage control, fast switching, ease of paralleling and temperature stability of electrical parameters.

Features:

- Single Event Effect (SEE) Hardened
- Ultra Low RDS(on)
- Low Total Gate Charge
- Simple Drive Requirements
- Ease of Paralleling
- Hermetically Sealed
- Ceramic Package
- Light Weight

Absolute Maximum Ratings

Pre-Irradiation

	Parameter		Units
Id @ VGS = 12V, TC = 25°C	Continuous Drain Current	18*	A
Id @ VGS = 12V, TC = 100°C	Continuous Drain Current	18*	
IDM	Pulsed Drain Current ①	72	
PD @ TC = 25°C	Max. Power Dissipation	75	W
	Linear Derating Factor	0.6	W/°C
VGS	Gate-to-Source Voltage	±20	V
EAS	Single Pulse Avalanche Energy ②	110	mJ
IAR	Avalanche Current ①	18	A
EAR	Repetitive Avalanche Energy ①	7.5	mJ
dv/dt	Peak Diode Recovery dv/dt ③	10	V/ns
TJ	Operating Junction	-55 to 150	°C
TSTG	Storage Temperature Range		
	Lead Temperature	300 (0.063in./1.6mm from case for 10sec)	
	Weight	4.3 (Typical)	g

* Current is limited by package

For footnotes refer to the last page

Electrical Characteristics @ T_j = 25°C (Unless Otherwise Specified)

	Parameter	Min	Typ	Max	Units	Test Conditions
B _V D _{SS}	Drain-to-Source Breakdown Voltage	60	—	—	V	V _{GS} = 0V, I _D = 1.0mA
ΔB _V D _{SS} /ΔT _J	Temperature Coefficient of Breakdown Voltage	—	0.057	—	V/°C	Reference to 25°C, I _D = 1.0mA
R _D S(on)	Static Drain-to-Source On-State Resistance	—	—	0.04	Ω	V _{GS} = 12V, I _D = 18A ④
V _{GS(th)}	Gate Threshold Voltage	2.0	—	4.0	V	V _{DS} = V _{GS} , I _D = 1.0mA
g _{fs}	Forward Transconductance	16	—	—	S	V _{DS} ≥ 15V, I _{DS} = 18A ④
I _{DSS}	Zero Gate Voltage Drain Current	—	—	10	μA	V _{DS} = 48V, V _{GS} = 0V
		—	—	25		V _{DS} = 48V, V _{GS} = 0V, T _J = 125°C
I _{GSS}	Gate-to-Source Leakage Forward	—	—	100	nA	V _{GS} = 20V
I _{GSS}	Gate-to-Source Leakage Reverse	—	—	-100		V _{GS} = -20V
Q _g	Total Gate Charge	—	—	45	nC	V _{GS} = 12V, I _D = 18A V _{DS} = 30V
Q _{gs}	Gate-to-Source Charge	—	—	10		
Q _{gd}	Gate-to-Drain ('Miller') Charge	—	—	15		
t _{d(on)}	Turn-On Delay Time	—	—	25	ns	V _{DD} = 30V, I _D = 18A, V _{GS} = 12V, R _G = 7.5Ω
t _r	Rise Time	—	—	100		
t _{d(off)}	Turn-Off Delay Time	—	—	35		
t _f	Fall Time	—	—	30		
L _S + L _D	Total Inductance	—	6.8	—	nH	Measured from drain lead (6mm/0.25in. from package) to source lead (6mm/0.25in. from package)
C _{iss}	Input Capacitance	—	1152	—	pF	V _{GS} = 0V, V _{DS} = 25V f = 1.0MHz
C _{oss}	Output Capacitance	—	535	—		
C _{rss}	Reverse Transfer Capacitance	—	42	—		

Source-Drain Diode Ratings and Characteristics

	Parameter	Min	Typ	Max	Units	Test Conditions
I _S	Continuous Source Current (Body Diode)	—	—	18*	A	T _j = 25°C, I _S = 18A, V _{GS} = 0V ④
I _{SM}	Pulse Source Current (Body Diode) ①	—	—	72		
V _{SD}	Diode Forward Voltage	—	—	1.2	V	T _j = 25°C, I _F = 18A, di/dt ≤ 100A/μs
t _{rr}	Reverse Recovery Time	—	—	99	ns	V _{DD} ≤ 25V ④
Q _{RR}	Reverse Recovery Charge	—	—	322	nC	
t _{on}	Forward Turn-On Time	Intrinsic turn-on time is negligible. Turn-on speed is substantially controlled by L _S + L _D .				

* Current is limited by package

Thermal Resistance

	Parameter	Min	Typ	Max	Units	Test Conditions
R _{thJC}	Junction-to-Case	—	—	1.67	°C/W	
R _{thJA}	Junction-to-Ambient	—	—	80		

Note: Corresponding Spice and Saber models are available on International Rectifier web site.

For footnotes refer to the last page

Radiation Characteristics

IRHY57034CM, JANSR2N7483T3

International Rectifier Radiation Hardened MOSFETs are tested to verify their radiation hardness capability. The hardness assurance program at International Rectifier is comprised of two radiation environments. Every manufacturing lot is tested for total ionizing dose (per notes 5 and 6) using the TO-3 package. Both pre- and post-irradiation performance are tested and specified using the same drive circuitry and test conditions in order to provide a direct comparison.

Table 1. Electrical Characteristics @ Tj = 25°C, Post Total Dose Irradiation ⑤⑥

	Parameter	Up to 500K Rads(Si) ¹		1000K Rads (Si) ²		Units	Test Conditions
		Min	Max	Min	Max		
BV _{DSS}	Drain-to-Source Breakdown Voltage	60	—	60	—	V	V _{GS} = 0V, I _D = 1.0mA
V _{GS(th)}	Gate Threshold Voltage	2.0	4.0	1.5	4.0		V _{GS} = V _{DS} , I _D = 1.0mA
I _{GSS}	Gate-to-Source Leakage Forward	—	100	—	100	nA	V _{GS} = 20V
I _{GSS}	Gate-to-Source Leakage Reverse	—	-100	—	-100		V _{GS} = -20 V
I _{DSS}	Zero Gate Voltage Drain Current	—	10	—	25	μA	V _{DS} =48V, V _{GS} =0V
R _{DS(on)}	Static Drain-to-Source ④ On-State Resistance (TO-3)	—	0.034	—	0.043	Ω	V _{GS} = 12V, I _D = 18A
R _{DS(on)}	Static Drain-to-Source ④ On-State Resistance (TO-257AA)	—	0.040	—	0.048	Ω	V _{GS} = 12V, I _D = 18A
V _{SD}	Diode Forward Voltage ④	—	1.2	—	1.2	V	V _{GS} = 0V, I _S = 18A

1. Part numbers IRHY57034CM (JANSR2N7483T3) , IRHY53034CM (JANSF2N7483T3) and IRHY54034CM (JANSQ2N7483T3)
2. Part number IRHY58034CM (JANSH2N7483T3)

International Rectifier radiation hardened MOSFETs have been characterized in heavy ion environment for Single Event Effects (SEE). Single Event Effects characterization is illustrated in Fig. a and Table 2.

Table 2. Typical Single Event Effect Safe Operating Area

LET (MeV/(mg/cm ²))	Energy (MeV)	Range (μm)	V _{DS} (V)				
			@V _{GS} = 0V	@V _{GS} = -5V	@V _{GS} = -10V	@V _{GS} = -15V	@V _{GS} = -20V
38 ± 5%	300 ± 7.5%	38 ± 7.5%	60	60	60	60	30
61 ± 5%	330 ± 7.5%	31 ± 10%	46	46	35	25	15
84 ± 5%	350 ± 10%	28 ± 7.5%	35	30	25	20	14

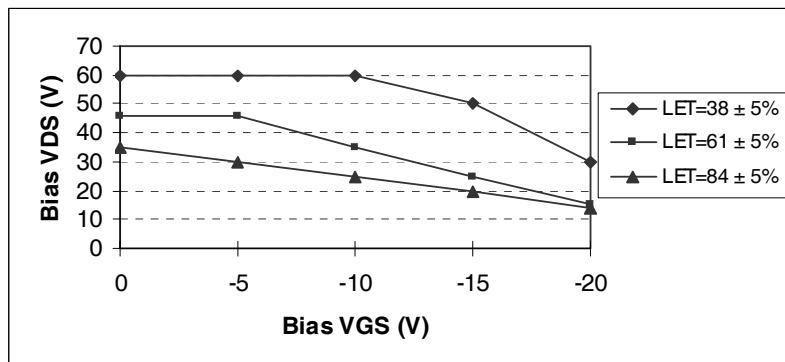

Fig a. Typical Single Event Effect, Safe Operating Area

For footnotes refer to the last page

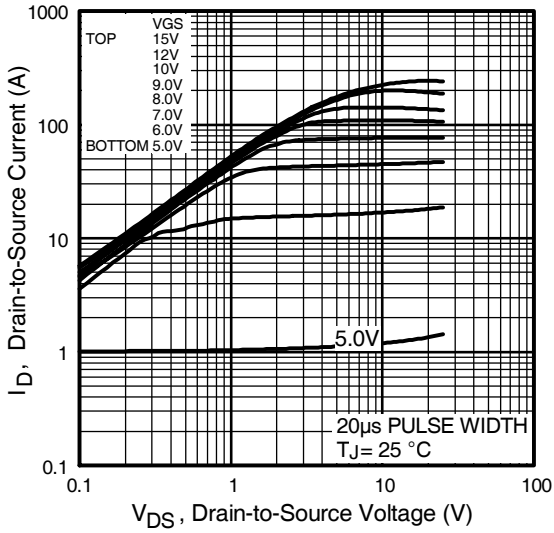

Fig 1. Typical Output Characteristics

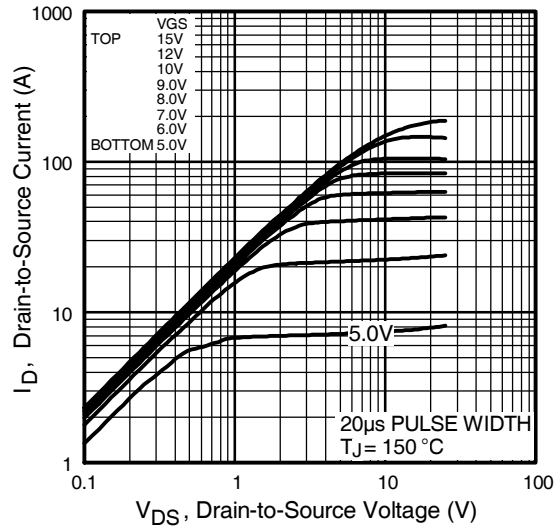

Fig 2. Typical Output Characteristics

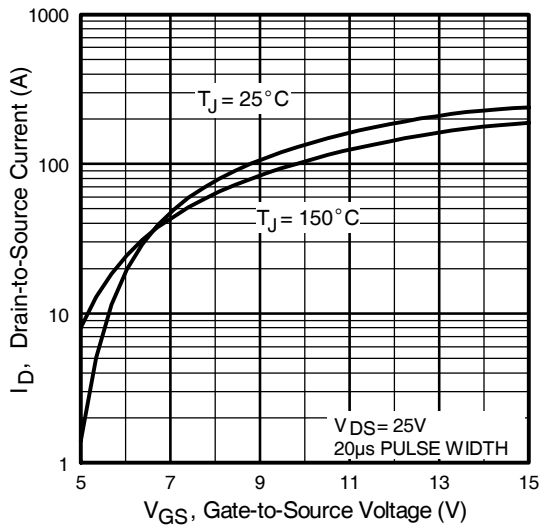

Fig 3. Typical Transfer Characteristics

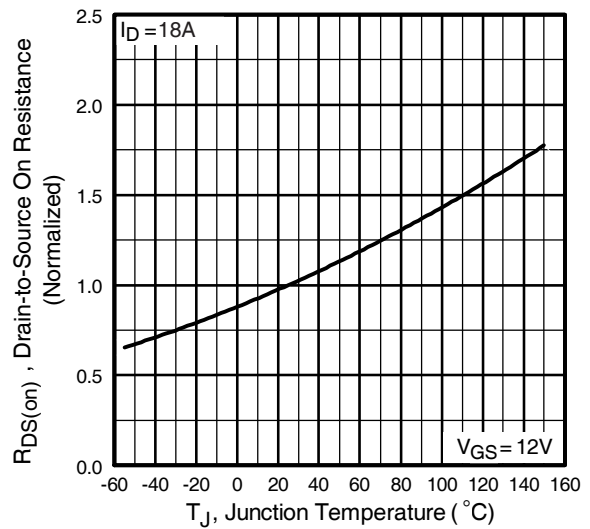

Fig 4. Normalized On-Resistance Vs. Temperature

Pre-Irradiation

IRHY57034CM, JANSR2N7483T3

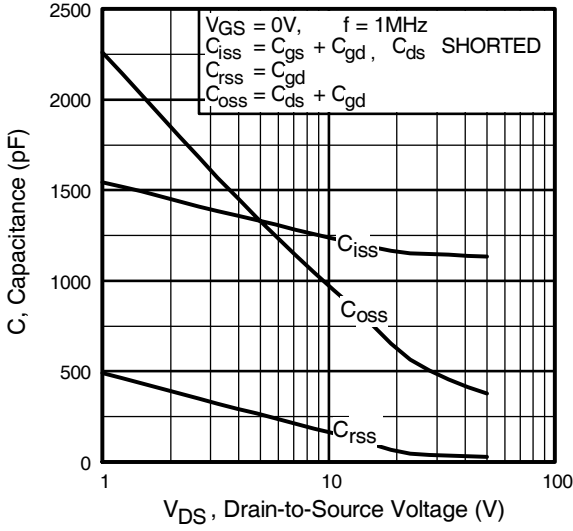

Fig 5. Typical Capacitance Vs. Drain-to-Source Voltage

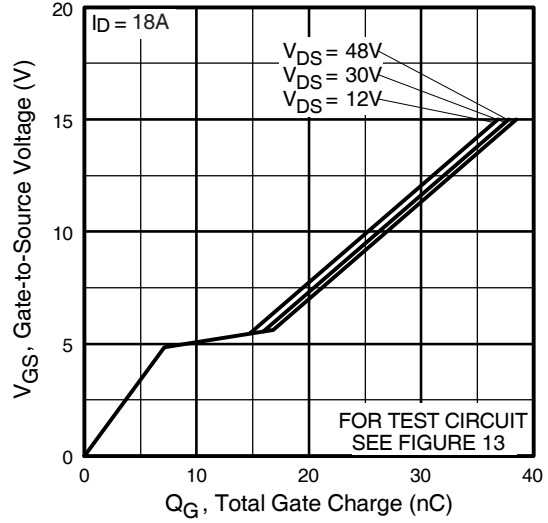

Fig 6. Typical Gate Charge Vs. Gate-to-Source Voltage

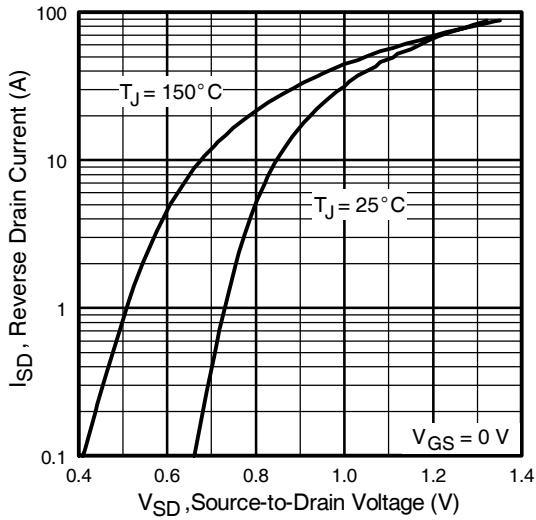

Fig 7. Typical Source-Drain Diode Forward Voltage

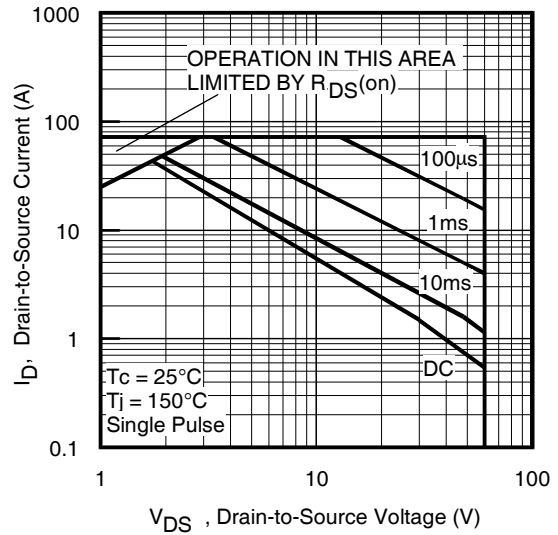

Fig 8. Maximum Safe Operating Area

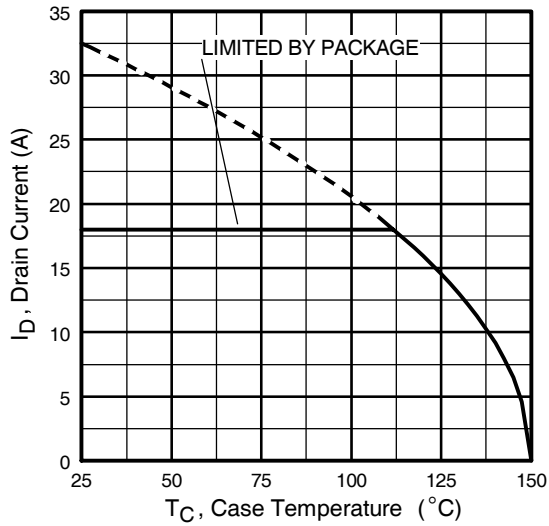

Fig 9. Maximum Drain Current Vs. Case Temperature

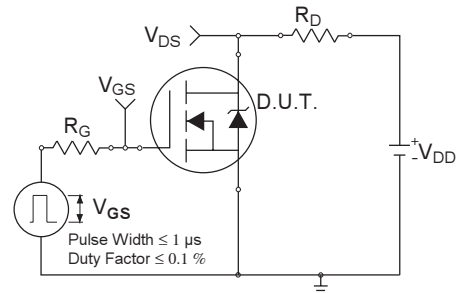

Fig 10a. Switching Time Test Circuit



Fig 10b. Switching Time Waveforms

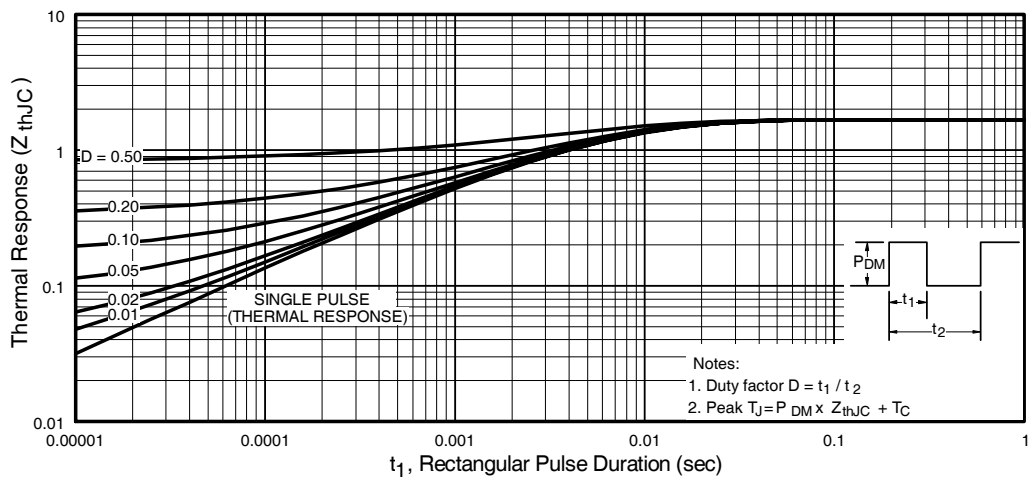

Fig 11. Maximum Effective Transient Thermal Impedance, Junction-to-Case

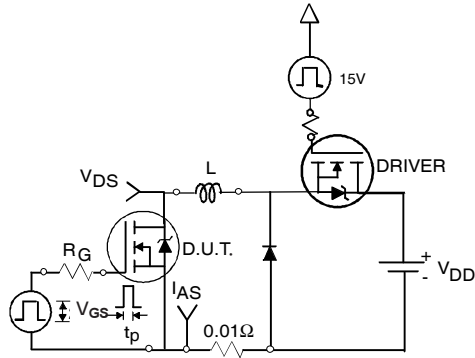

Fig 12a. Unclamped Inductive Test Circuit



Fig 12b. Unclamped Inductive Waveforms

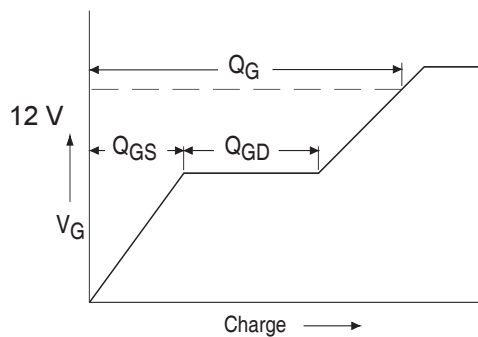

Fig 13a. Basic Gate Charge Waveform

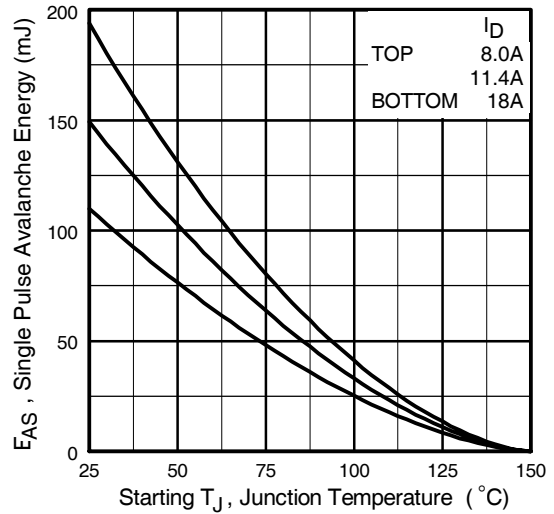

Fig 12c. Maximum Avalanche Energy Vs. Drain Current

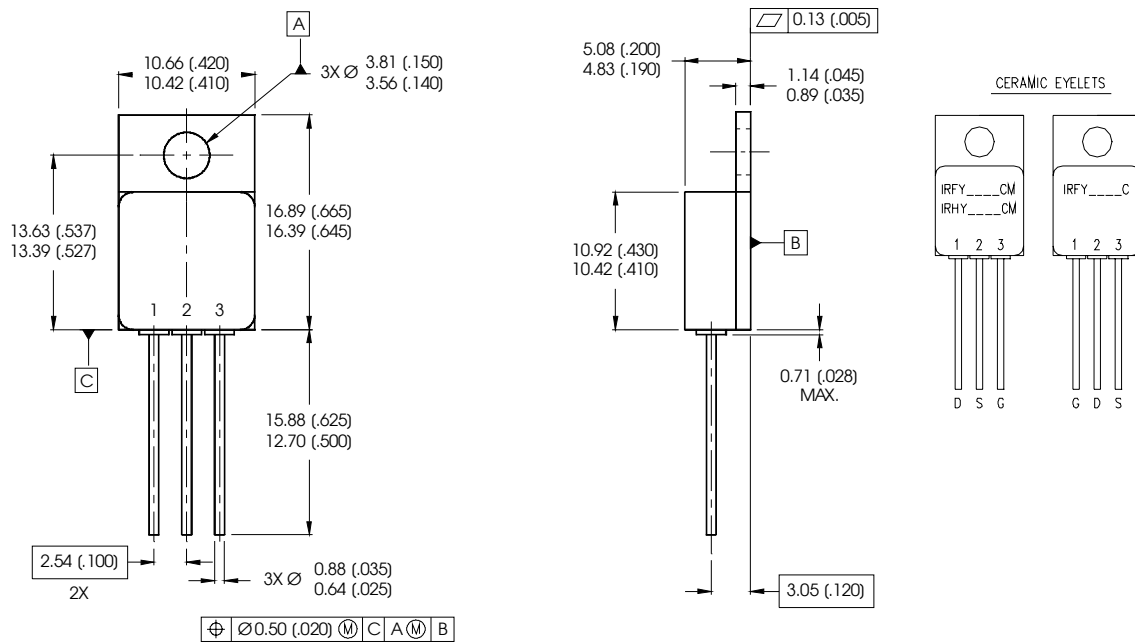

Fig 13b. Gate Charge Test Circuit

Footnotes:

- ① Repetitive Rating; Pulse width limited by maximum junction temperature.
- ② $V_{DD} = 25V$, starting $T_J = 25^\circ C$, $L = 0.7\text{ mH}$
Peak $I_L = 18A$, $V_{GS} = 12V$
- ③ $I_{SD} \leq 18A$, $di/dt \leq 234A/\mu s$,
 $V_{DD} \leq 60V$, $T_J \leq 150^\circ C$
- ④ Pulse width $\leq 300\ \mu s$; Duty Cycle $\leq 2\%$
- ⑤ **Total Dose Irradiation with VGS Bias.**
12 volt V_{GS} applied and $V_{DS} = 0$ during irradiation per MIL-STD-750, method 1019, condition A.
- ⑥ **Total Dose Irradiation with VDS Bias.**
48 volt V_{DS} applied and $V_{GS} = 0$ during irradiation per MIL-STD-750, method 1019, condition A.

Case Outline and Dimensions — TO-257AA



NOTES:

- 1. DIMENSIONING & TOLERANCING PER ANSI Y14.5M-1994.
- 2. CONTROLLING DIMENSION: INCH.
- 3. DIMENSIONS ARE SHOWN IN MILLIMETERS (INCHES).
- 4. OUTLINE CONFORMS TO JEDEC OUTLINE TO-257AA.

PIN ASSIGNMENTS

- 1 = DRAIN
- 2 = SOURCE
- 3 = GATE

International
IR Rectifier

IR WORLD HEADQUARTERS: 233 Kansas St., El Segundo, California 90245, USA Tel: (310) 252-7105

IR LEOMINSTER : 205 Crawford St., Leominster, Massachusetts 01453, USA Tel: (978) 534-5776

TAC Fax: (310) 252-7903

Visit us at www.irf.com for sales contact information.

Data and specifications subject to change without notice. 10/2011